

NOTES:

1. Material: N-BK7;
2. G - Fine ground surface;
3. All dimensions are in mm;
4. Centration error: ≤ 3 arcmin;
5. Protective chamfers: 0.3 mm x 45°;
6. Radius tolerance: $\pm 1\%$;

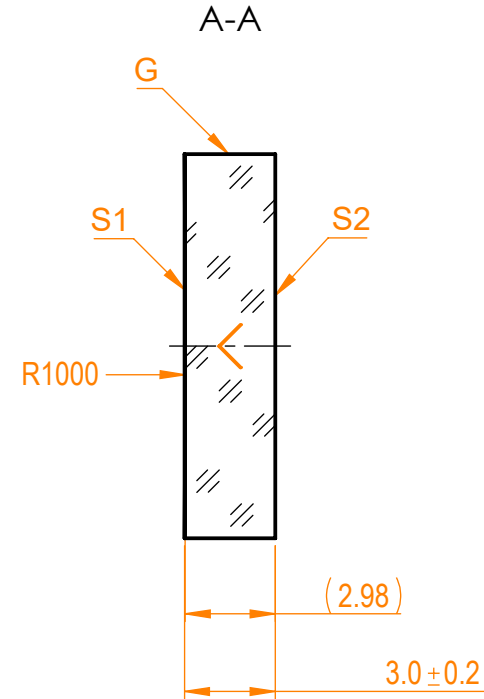

Isometric view 1:1

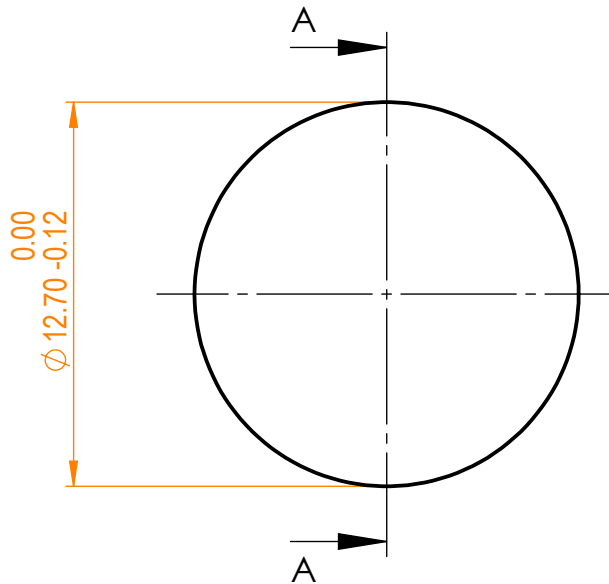

Specifications are subject to change without notice
Dimensions are for reference only

Parameters				 info@eksmaoptics.com www.eksmaoptics.com		N-BK7 pl/cv window, D=12.7 mm, T=3 mm					
	S1	S2									
Shape	Concave	Plano									
Radius of curvature	1000	Infinity									
Surface irregularity	$\lambda/10$ @633nm	$\lambda/10$ @633nm									
Surface quality	20-10 s/d	20-10 s/d									
Clear aperture	$\geq 90\%$	$\geq 90\%$									
Coating	-	-									
				Proprietary The information in this drawing is property of EKSMA Optics. Any reproduction in part or as a whole without the written permission of EKSMA Optics is prohibited.		Approved Drawn	Name A.K. V.S.	Date 2020.11.16 2020.11.16	Part number 010-0120E	Rev. A	Scale 4:1