

NOTES:

1. Material: N-BK7;
2. G - Fine ground surface;
3. All dimensions are in mm;
4. Centration error:  $\leq 3$  arcmin;
5. Protective chamfers: 0.3 mm x 45°;
6. Radius tolerance:  $\pm 1\%$ ;

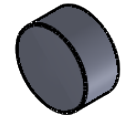

Isometric view 1:1

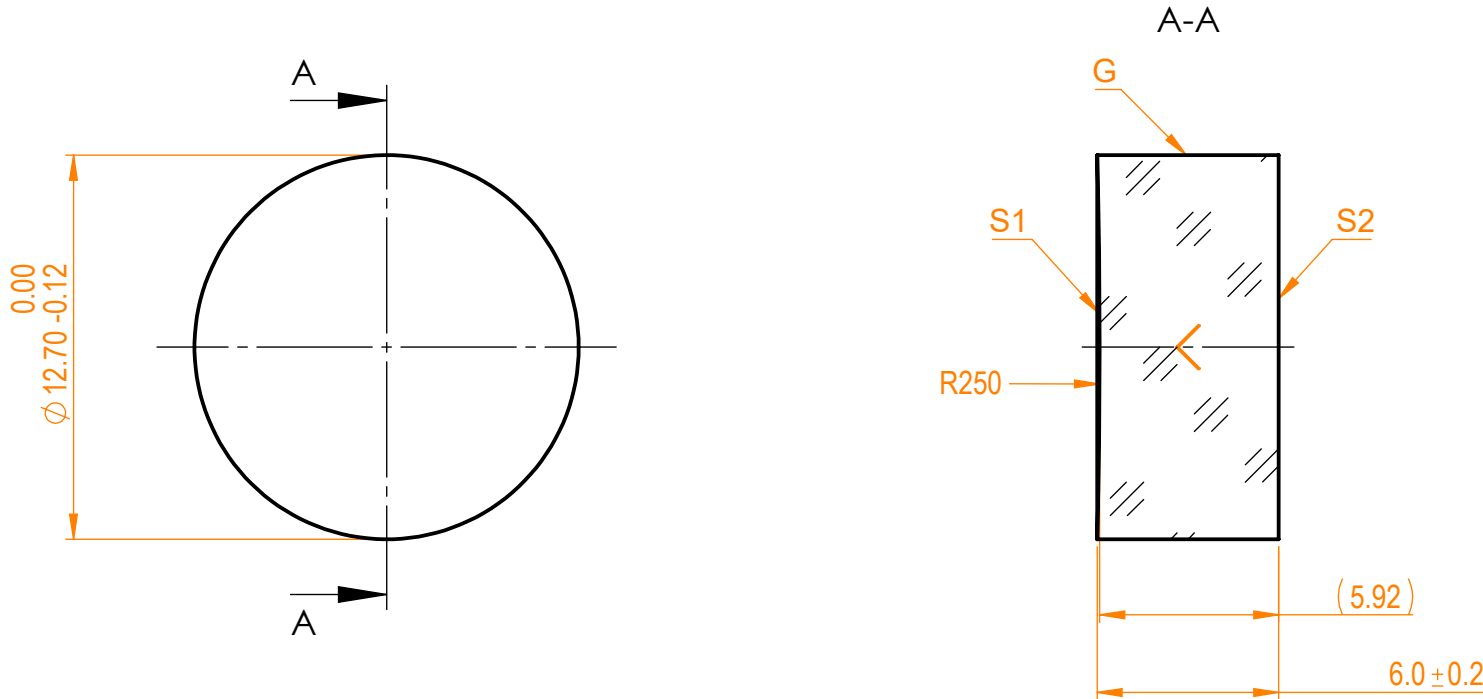

Specifications are subject to change without notice  
Dimensions are for reference only

Parameters				 info@eksmaoptics.com www.eksmaoptics.com		N-BK7 pl/cv window, D=12.7 mm, T=6 mm				
	S1	S2								
Shape	Concave	Plano								
Radius of curvature	250	Infinity								
Surface irregularity	$\lambda/10$ @633nm	$\lambda/10$ @633nm								
Surface quality	20-10 s/d	20-10 s/d								
Clear aperture	$\geq 90\%$	$\geq 90\%$								
Coating	-	-								
				Proprietary		Name	Date	Part number	Rev.	Scale
				The information in this drawing is property of EKSMA Optics. Any reproduction in part or as a whole without the written permission of EKSMA Optics is prohibited.	Approved	A.K.	2020.11.16	010-0110T6	A	4:1
					Drawn	V.S.	2020.11.16			