

PC12SR-755 DKDP (KD*P) Pockels cell

Crystal size: diameter 12 x 24 mm, both ends parallel

Clear aperture: diameter 11.0 mm

Quarter wave voltage at 755 nm: < 2.5 kV DC (estimated, not measured)

Quarter wave voltage at 1064 nm: < 3.4 kV DC (measured)

Capacitance: 6 pF

Optical transmission: > 97 % at 755 nm

Contrast ratio in crossed polarizers (ICR): > 1:2000 (no voltage is applied; measured at 1064 nm)

Damage threshold of dielectric AR coatings: > 0.5 GW/cm² (> 5 J/cm²), 1064 nm, 10 Hz, 10 ns

With protective windows on both ends

Cell size: diameter 35 mm x 41.6 mm (L)

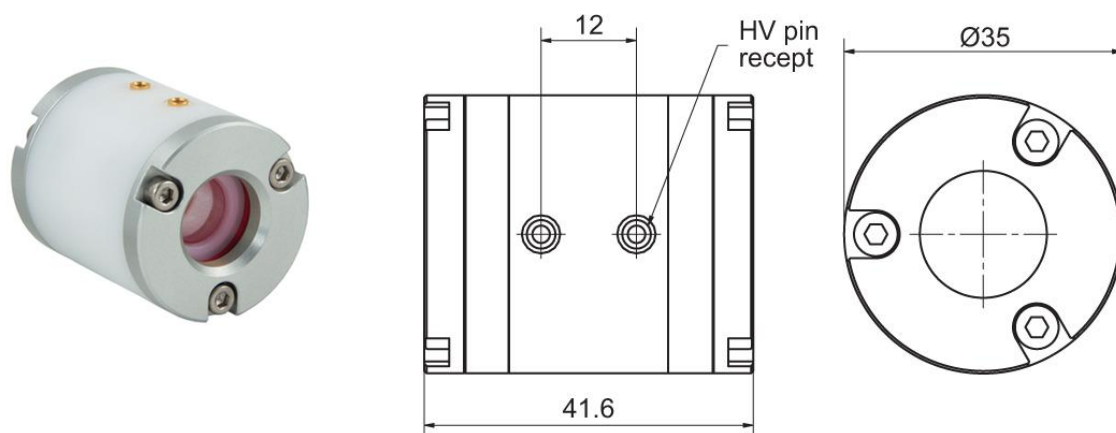

Outline picture and drawing of **PC12SR** DKDP (KD*P) Pockels cell

The specifications are subject to change without any notice in advance.