

AIR-COOLED BEAM DUMP – 990-0800



990-0800

Beam Dump 990-0800 is designed to block CW or pulsed laser beams. It can be used on beams of up to 50 W in the wavelength range from 0.1 to 30 μm .

Due to the design of the beam dump, even if the non-reflective coating is damaged by high intensity pulses, there is no backward reflection.

990-0801 is a smaller beam dump designed to block a CW or a pulsed laser beam. It can be used on beams of up to 5 Watts in the wavelength range from 0.1 to 30 μm .

SPECIFICATIONS

Wavelength range	0.1 – 30 μm
Laser type	pulsed, CW

Aperture	Description	Catalogue number	Price, EUR
48 mm	for beams up to 50 W	990-0800	169
20 mm	for beams up to 5 W	990-0801	119

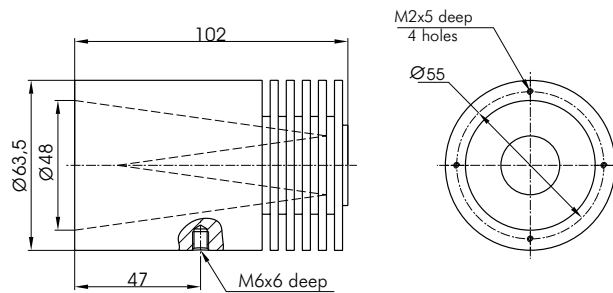

Drawing of 990-0800

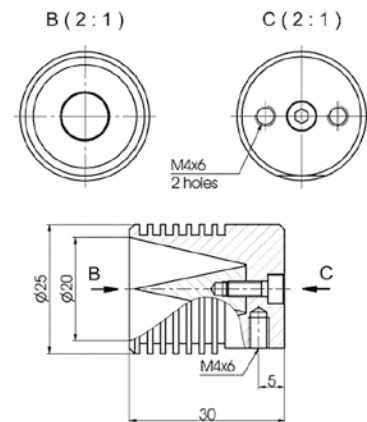

Drawing of 990-0801

WATER-COOLED BEAM DUMP – 990-0820



990-0820

Beam Dump 990-0820 is designed to block CW or pulsed laser beams. It is mainly intended for beams 2 inch wide.

The dump is best suited for beams of up to 1 kW from 0.1 – 30 μm wavelength range. Even if the non-reflective coating is damaged by high intensity pulses, the beam is not reflected back into your optical scheme.

The dump mounts on M6 hole on its back.

SPECIFICATIONS

Wavelength range	0.1 – 30 μm
Max. handling power	1 kW
Max. energy	50 J (20 Hz)
Acceptance aperture	48 mm (1.89")
Laser type	pulsed, CW
Weight	1.2 kg

Catalogue number	Price, EUR
990-0820	239

