

D-compact/9-1064 DKDP (KD*P) Pockels cell

Clear aperture: diameter 8.0 mm

Quarter wave voltage at 1064 nm: < 3.4 kV DC

Capacitance: 6 pF

Optical transmission: > 97 % at 1064 nm

Contrast ratio in crossed polarizers (ICR): > 1:2000 (no voltage is applied)

Damage threshold of dielectric AR coatings: > 0.5 GW/cm² (> 5 J/cm²), 1064 nm, 10 Hz, 10 ns

With protective windows on both ends

Cell size: diameter 25.4 mm x 35 mm (L)

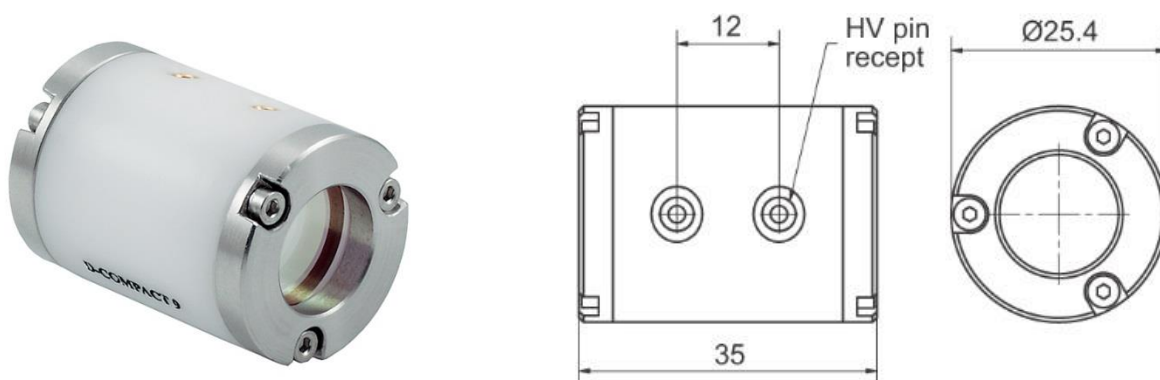

Outline picture and drawing of **D-compact/9** DKDP (KD*P) Pockels cell

The specifications are subject to change without any notice in advance.